

S-100 TS-4 Series Tiny Toggle Switches



NEW



S-100 1,3PIN
6A120V 3A250V

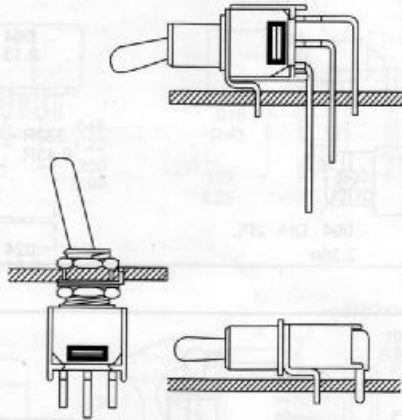

SPECIFICATION:

CONTACT RATING : 3A120VAC, 28VDC or 0.4VA
 S-100 : 6A 120V, 3A 250V
 ELECTRICAL LIFE : 30,000 make-and-break cycles at full load
 CONTACT RESISTANCE : 20 milliohms max. initial @ 2-4 VDC,
 100 milliamps for both coin silver and gold plated contacts.
 INSULATION RESISTANCE : 1,000 MΩ min.
 DIELECTRIC STRENGTH : 1,000 RMS @ sea level.
 OPERATING TEMPERATURE : -30°C to 130°C

MATERIALS:

Case-diallyl phthalate (DAP)
 TOGGLE HANDLE-Brass, nickel plated
 BUSHING-Brass, nickel plated
 HOUSING-Stainless Steel.
 TERMINAL/SWITCH SUPPORT-Brass electrotin plated
 CONTACTS-Coin silver, silver plated, or gold plated.
 CENTER CONTACT & TERMINALS-Brass, silver plated, or gold plated.

TS-4 COLOR C

SPDT



TS-41BSTQ,
S-100

| Model NO. | Switching Position | |
|-------------|--------------------|----------|
| TS - 40 | ON | OFF |
| TS - 41 | ON | ON |
| TS - 42 | ON | (ON) |
| TS - 43 | ON | OFF ON |
| Term. Comm. | 2-3 | OPEN 2-1 |

Schematic

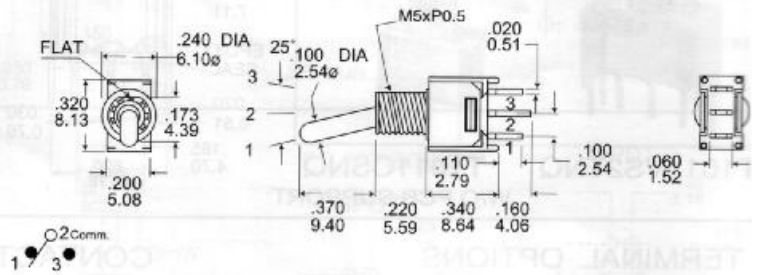

DPDT



TS-51BSTQ

| Model NO. | Switching Position | |
|-------------|--------------------|---------------|
| TS - 50 | ON | OFF |
| TS - 51 | ON | ON |
| TS - 52 | ON | (ON) |
| TS - 53 | ON | OFF ON |
| Term. Comm. | 2-3, 5-6 | OPEN 2-1, 5-4 |

Schematic

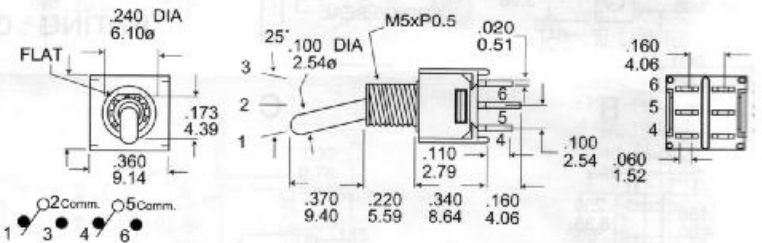

TERMINAL OPTIONS

SPDT



TS-41P

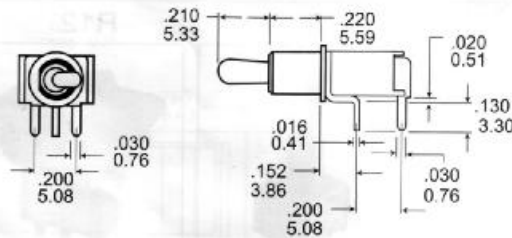

P.C. MOUNTING

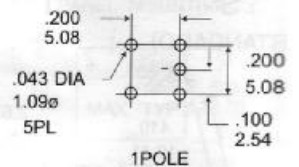

DPDT



TS-51P

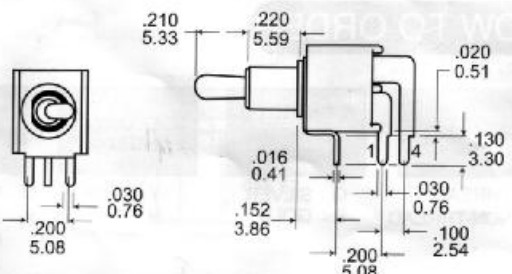

P.C. MOUNTING

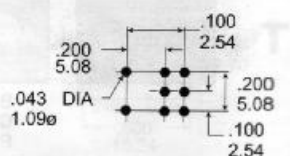

TS-4 Tiny Toggle , Tiny Rocker Switches



SPDT

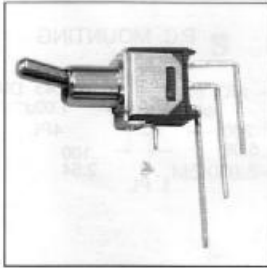

TS-41L

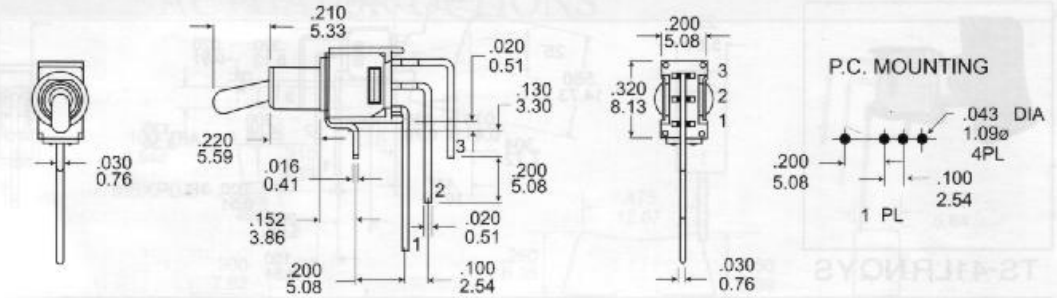

DPDT



TS-51L

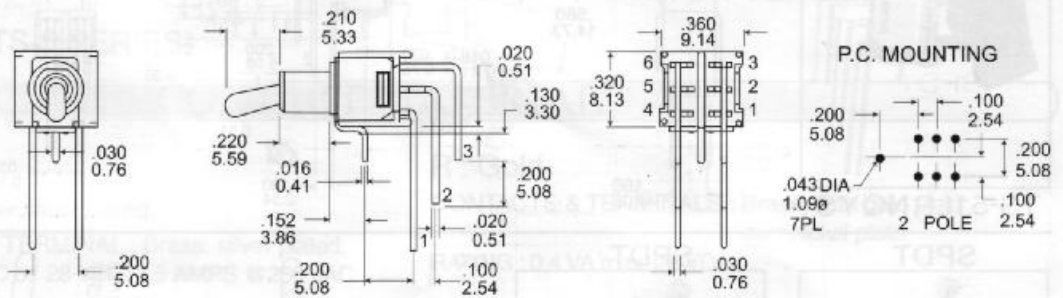

DPDT

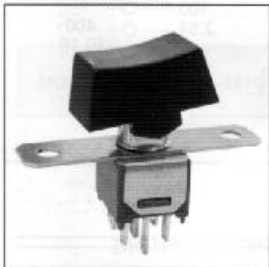

TS-51BRNQNK

SPDT

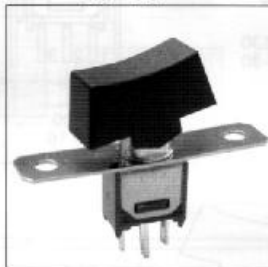

TS-41BRNQNK W/ SCREW BRACKET

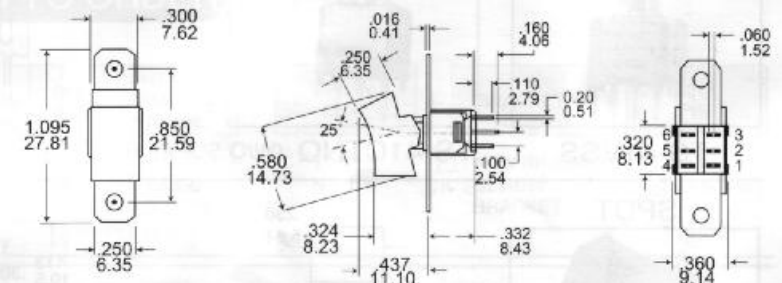

SPDT



TS-41PR

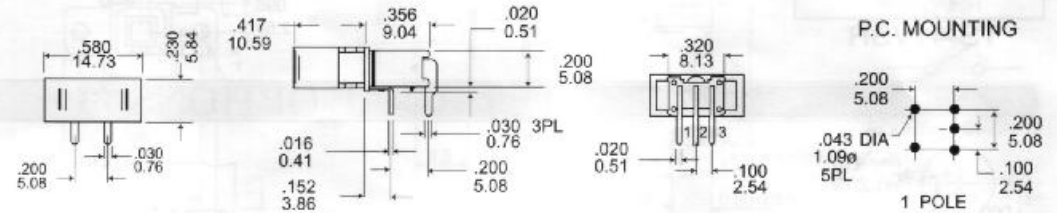

DPDT



TS-51PR

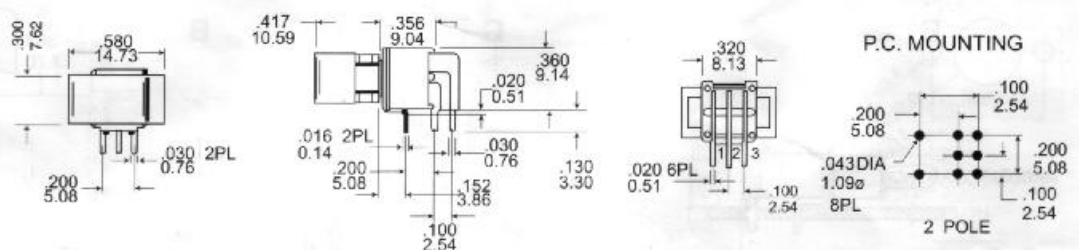

TS-4 Tiny Toggle Rocker Switches



SPDT

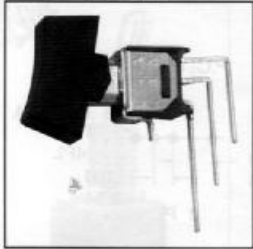

TS-41LRNQYS

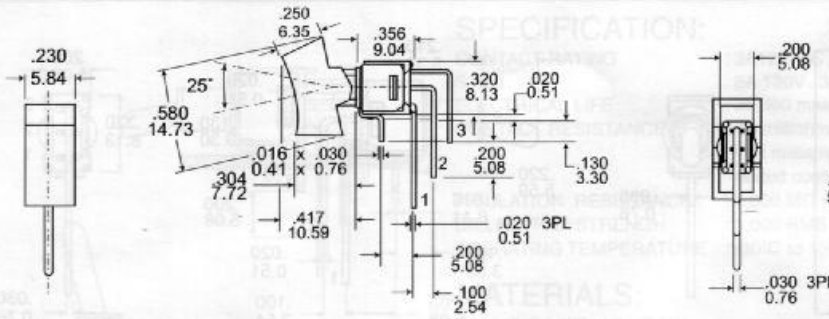

P.C. MOUNTING

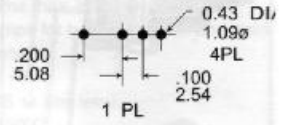

DPDT

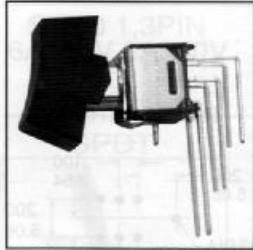

TS-51LRNQYS

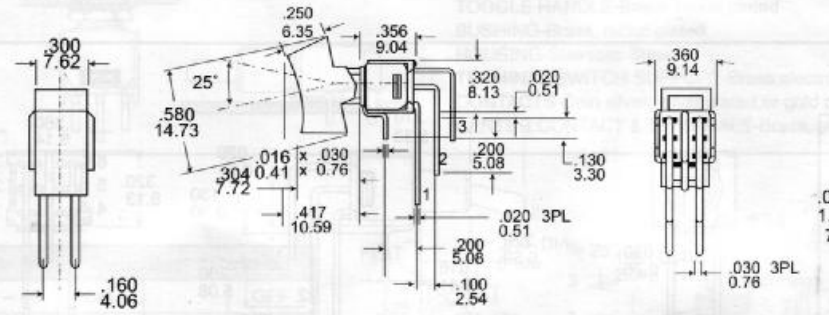

P.C. MOUNTING

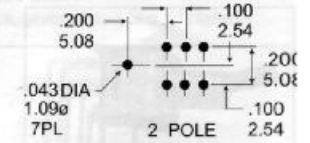

SPDT

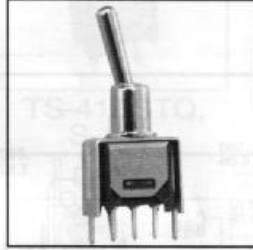

TS-41VSS

SPDT

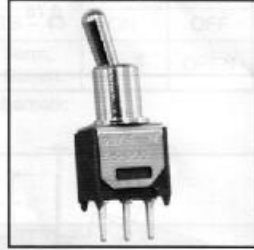

TS-41CTNQ (W/O SUPPORT)

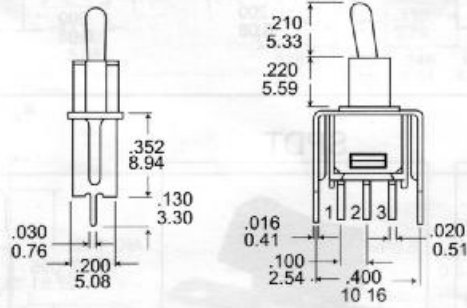

P.C. MOUNTING

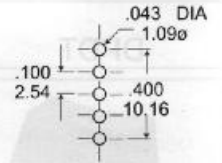

SPDT

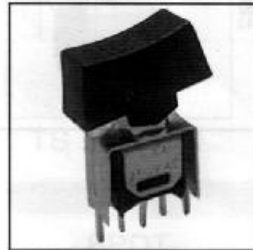

TS-41VSR

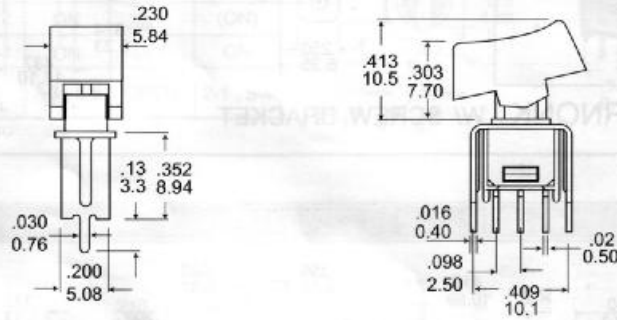

P.C. MOUNTING

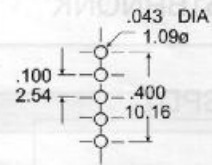

TERMINAL OPTIONS

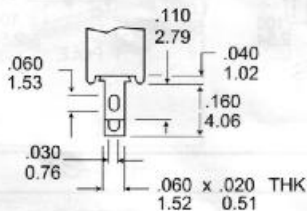

B

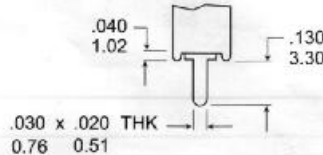

C

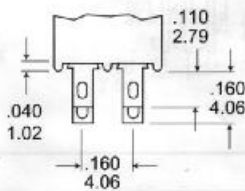

B

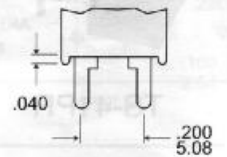

C

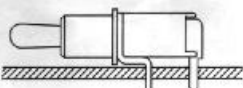

P

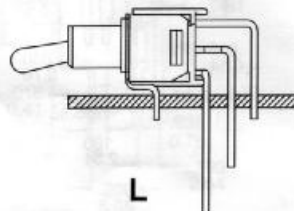

L

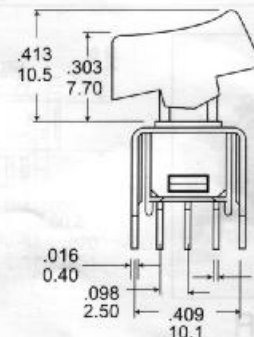

VS

DPDT

TS-4 Tiny Toggle Paddle Switches



ACTUATOR OPTIONS

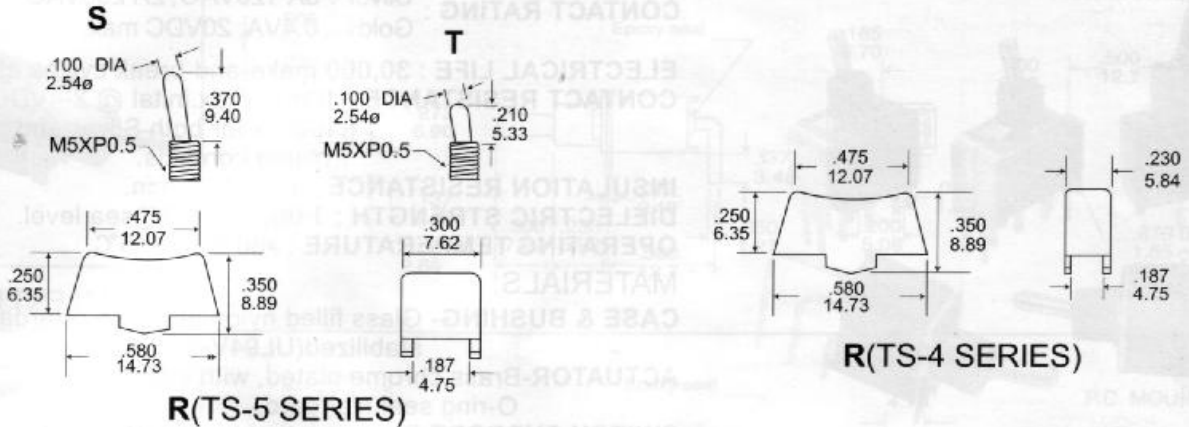

CONTACT MATERIAL

Q : Silver

END CONTACTS : Coin silver, silver plated.

CENTER CONTACT & ALL TERMINAL : Brass, silver plated.

RATING : 3 AMPS @ 120 VAC or 28 VDC; 1.5 AMPS @ 250 VAC.

R : Gold

CONTACTS & TERMINALS : Brass, with gold plate over nickel plate.

RATING : 0.4 VA max. 20 VDC.

HOW TO ORDER

