

NINGBO TIANBO GANGLIAN ELECTRONICS.,LTD

TRAW

SPECIFICATION

FILE NUMBER: T810S-A004A

DATE: 2004/06/25

■ CONTACT DATA

Contact Form	1H, 1D, 1Z/SH, SD, SZ	
Contact Material	Silver Alloy	
Contact Ratings	1 FORM:10A 14VDC S FORM:15A 14VDC	
Max Switching Voltage	75VDC	
Max Switching Current	20A	
Max Switching Power	200W	
Contact Resistance	100m Ω Max	at 6VDC 1A
Life Expectancy Electrical	100, 000	Operations(at30Operations/minute)
Machanical	10, 000, 000	Operations

■ GENERAL DATA

Insulation Resistance	100M Ω Min at 500VDC
Dielectric Strength Between Open Contacts	500VAC(for one minute)
Between Contacts and coil	500VAC(for one minute)
Operate Time	5ms
Release Time	3ms
Temperature Range	-40 $^{\circ}$ C to+85 $^{\circ}$ C
Shock Resistance	20G 11ms
Vibration Resistance	10-55Hz,1.5mm
Humidity	40-85%
Weight	Approx 9.5g
Safety Standard	

■ COIL DATA

Nominal Voltage (VDC)	Coil Resistance at20 $^{\circ}$ C \pm 10%(Ω)	Max Operate Voltage VDC	Min Release Voltage VDC	Max Applicable Voltage VDC
	1.1W			
6	28	3.9	0.3	7.8
9	70	5.9	0.45	11.7
12	130	7.8	0.6	15.6
18	290	11.8	0.9	23.4
24	520	15.6	1.2	31.2

■ ORDERING CODE

TRAW—12VDC—S—1Z

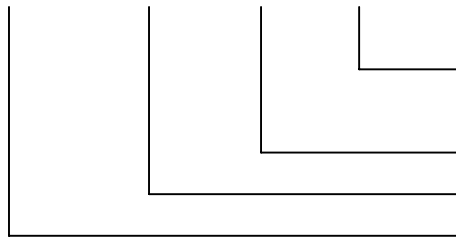

1Z Form 1C 1D Form 1B 1H Form 1A
 SZ 1Form W SD 1Form V SH 1Form U
 Sealed K:OPEN TYPE
 Coil Nominal Voltage
 Relay Model

■ OVERALL AND MOUNTING DIMENSIONS

TRAW Sealed

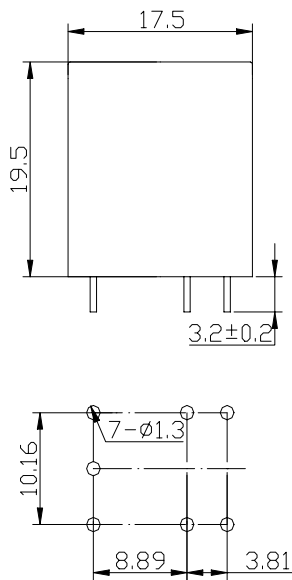

TRAW Open

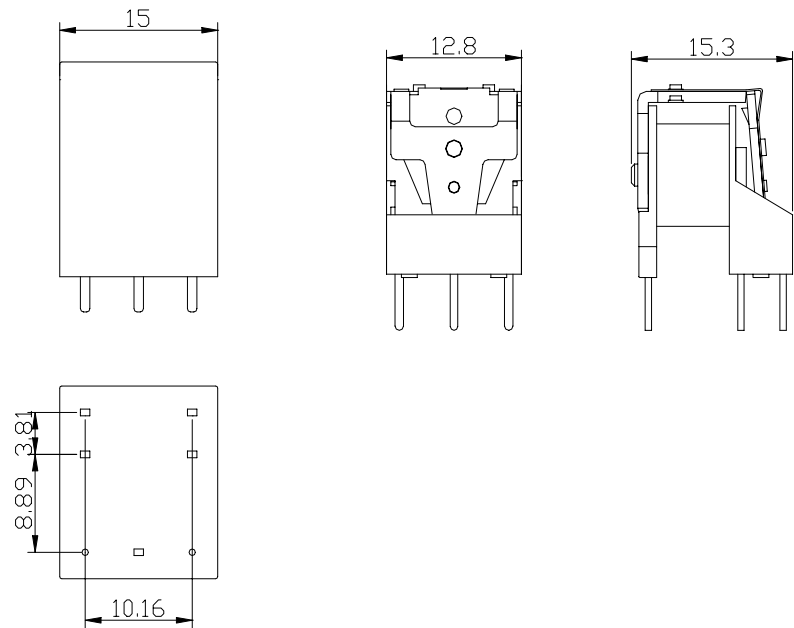

wiring Diagrams (Bottom View)

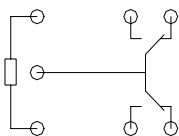

SZ

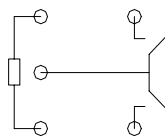

SH

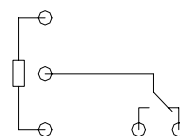

1Z

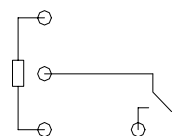

1H